



MA-727 / MA-828 / MA-929

PORTABLE WIRELESS PA SYSTEM

User Guide





IMPORTANT SAFETY INSTRUCTIONS

1. Read these instructions.
2. Keep these instructions.
3. Heed all warnings.
4. Follow all instructions.
5. Do not use this apparatus near water.
6. Clean only with a dry cloth.
7. Do not block any ventilation openings. Install in accordance with the manufacturer's instructions.
8. Do not install near any heat sources such as radiators, heat registers, stoves, or other apparatus (including amplifiers) that produce heat.
9. Do not defeat the safety purpose of the polarised or ground plug: A polarised plug has two blades with one wider than the other. The wide blade is provided for your safety. When the provided plug does not fit into your outlet, consult an electrician for replacement of the obsolete outlet.
10. Protect the power cord from being walked on or pinched particularly at plug, convenience receptacles, and the point where they exit from the apparatus.
11. Only use attachments/accessories specified by the manufacturer.
12. Use only with a cart, stand, tripod, bracket, or table specified by the manufacturer, or sold with the apparatus. When a cart is used, use caution when moving the cart / apparatus combination to avoid injury from tip-over.
13. Unplug this apparatus during lightning storms or when unused for long periods of time.
14. Refer all servicing to qualified service personnel. Servicing is required when the apparatus has been damaged in any way, such as power-supply cord or plug is damaged, liquid has been spilled or objects have fallen into the apparatus, the apparatus has been exposed to rain or moisture, does not operate normally, or has been dropped.
15. If Service Instruction in Owner's Manual: "Caution - These servicing instructions are for use by qualified service personnel only. To reduce the risk of electric shock do not perform any servicing other than that contained in the operating instructions unless you are qualified to do so.
16. The equipment is a Class I apparatus, shall be connected to a mains socket outlet with a protective earthing connection.
17. Warning: To reduce the risk of fire or electric shock, do not expose this apparatus to rain or moisture and objects filled with liquids, such as vases, should not be placed on this apparatus.
18. To completely disconnect this apparatus from the ac mains, disconnect the power supply cord plug from the ac receptacle. Pour deconnecter completement l'appareil du reseau d'alimentation, deconnecter le cordon d'alimentation de la prise murale.
19. The mains plug of the power supply cord shall remain readily accessible. La prise du reseau d'alimentation doit demeurer aisement accessible.
20. Warning: Do not expose batteries or battery pack to excessive heat such as sunshine, fire or the like.
Avertissement: Les batteries ou bloc de batteries ne doivent pas etre exposees a une chaleur excessive telle que celle du soleil, feu ou autre source de chaleur similaire.
21. Caution: Danger of explosion if battery is incorrectly replaced. Replace only with the same or equivalent type. Attention: Danger d'explosion si la pile n'est pas remplacée correctement. Ne remplacer que par le même type ou un type équivalent.



WARNING

1. **FOR OUTDOOR USE:**
To reduce the risk of fire or electric shock, do not expose this apparatus to rain or moisture.
2. **UNDER WET LOCATION:**
Apparatus should not be exposed to dripping or splashing and no objects filled with liquids, such as vases should be placed on the apparatus.
3. **SERVICE INSTRUCTIONS:**
CAUTION - These servicing instructions are for use by qualified service personnel only. To reduce the risk of electric shock, do not perform any servicing other than that contained in the operating instructions unless you are qualified to do so.

	
	This symbol indicates that dangerous voltage constituting a risk of electric shock is present within this unit.
	This symbol indicates that there are important operating and maintenance instructions in the literature accompanying this unit.

FC & IC - ID

THIS DEVICE COMPLIES WITH PART15 OF THE FCC RULES AND RSS-123 ISSUE2 OF CANADA. OPERATION IS SUBJECT TO THE FOLLOWING TWO CONDITIONS:

- (1) This device may not cause interference.
- (2) This device must accept any interference, including interference that may cause undesired operation of the device. This equipment complies with FCC RF radiation exposure limits set forth for an uncontrolled environment.

Disposal Dispose of any unusable devices or batteries responsibly and in accordance with any applicable regulations.

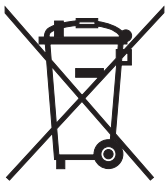

Disposing of used batteries with domestic waste is to be avoided!

Batteries/NiCad cells often contain heavy metals such as cadmium(Cd), mercury(Hg) and lead(Pb) that makes them unsuitable for disposal with domestic waste. You may return spent batteries/accumulators free of charge to recycling centres or anywhere else batteries/accumulators are sold.

2005-08-13

By doing so, you contribute to the conservation of our environment!



“This product can only be used at the area that the altitude is lower than 2000m for safety purpose.”



“This product can be used in non-tropical locations only for safety purpose.”

Federal Communication Commission Interference Statement

This equipment has been tested and found to comply with the limits for a Class B digital device, pursuant to Part 15 of the FCC Rules. These limits are designed to provide reasonable protection against harmful interference in a residential installation.

This equipment generates, uses and can radiate radio frequency energy and, if not installed and used in accordance with the instructions, may cause harmful interference to radio communications. However, there is no guarantee that interference will not occur in a particular installation. If this equipment does cause harmful interference to radio or television reception, which can be determined by turning the equipment off and on, the user is encouraged to try to correct the interference by one of the following measures:

- Reorient or relocate the receiving antenna.
- Increase the separation between the equipment and receiver.
- Connect the equipment into an outlet on a circuit different from that to which the receiver is connected.
- Consult the dealer or an experienced radio/TV technician for help.

FCC Caution: To assure continued compliance, any changes or modifications not expressly approved by the party responsible for compliance could void the user's authority to operate this equipment. (Example - use only shielded interface cables when connecting to computer or peripheral devices).

FCC Radiation Exposure Statement

This equipment complies with FCC RF radiation exposure limits set forth for an uncontrolled environment. This equipment should be installed and operated with a minimum distance of 20 centimeters between the radiator and your body.

This transmitter must not be co-located or operating in conjunction with any other antenna or transmitter.

The antennas used for this transmitter must be installed to provide a separation distance of at least 20 cm from all persons and must not be co-located or operating in conjunction with any other antenna or transmitter.

THIS DEVICE COMPLIES WITH PART 74 AND PART 15 OF THE FCC RULES. This equipment complies with FCC RF radiation exposure limits set forth for an uncontrolled environment.

This device complies with Industry Canada licence-exempt RSS-123 ISSUE 2 and RSS-210 ISSUE 8 standard. Operation is subject to the following two conditions: (1) this device may not cause interference, and (2) this device must accept any interference, including interference that may cause undesired operation of the device.

I. Parts Name

1. Front and Rear Panels:

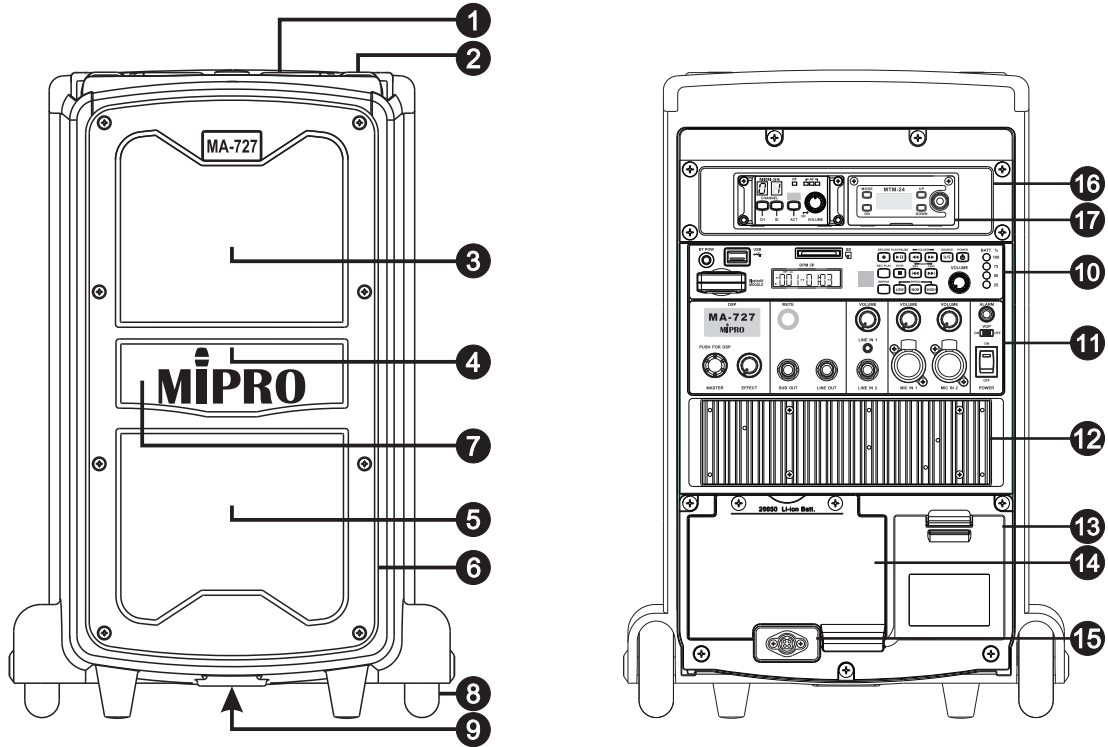

Fig. 1a: MA-727

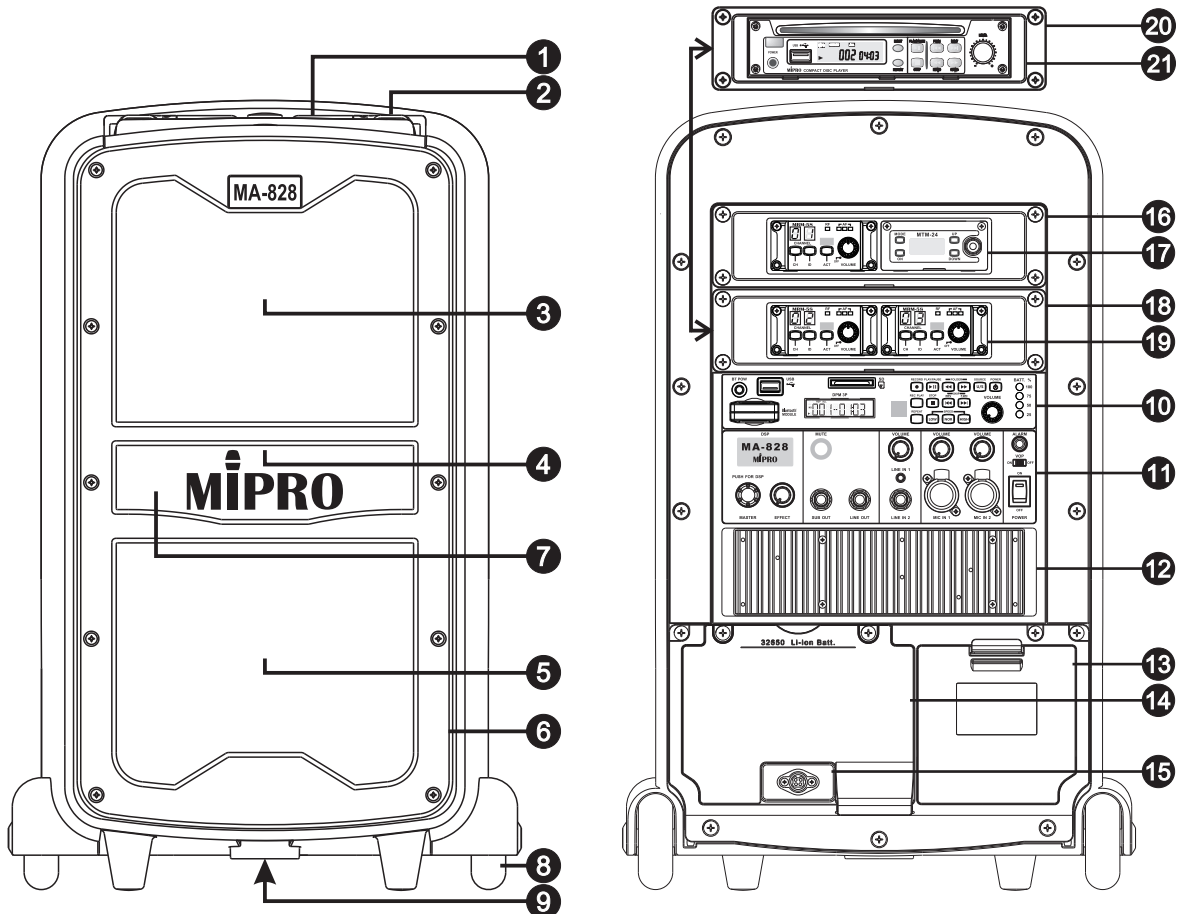

Fig. 1b: MA-828

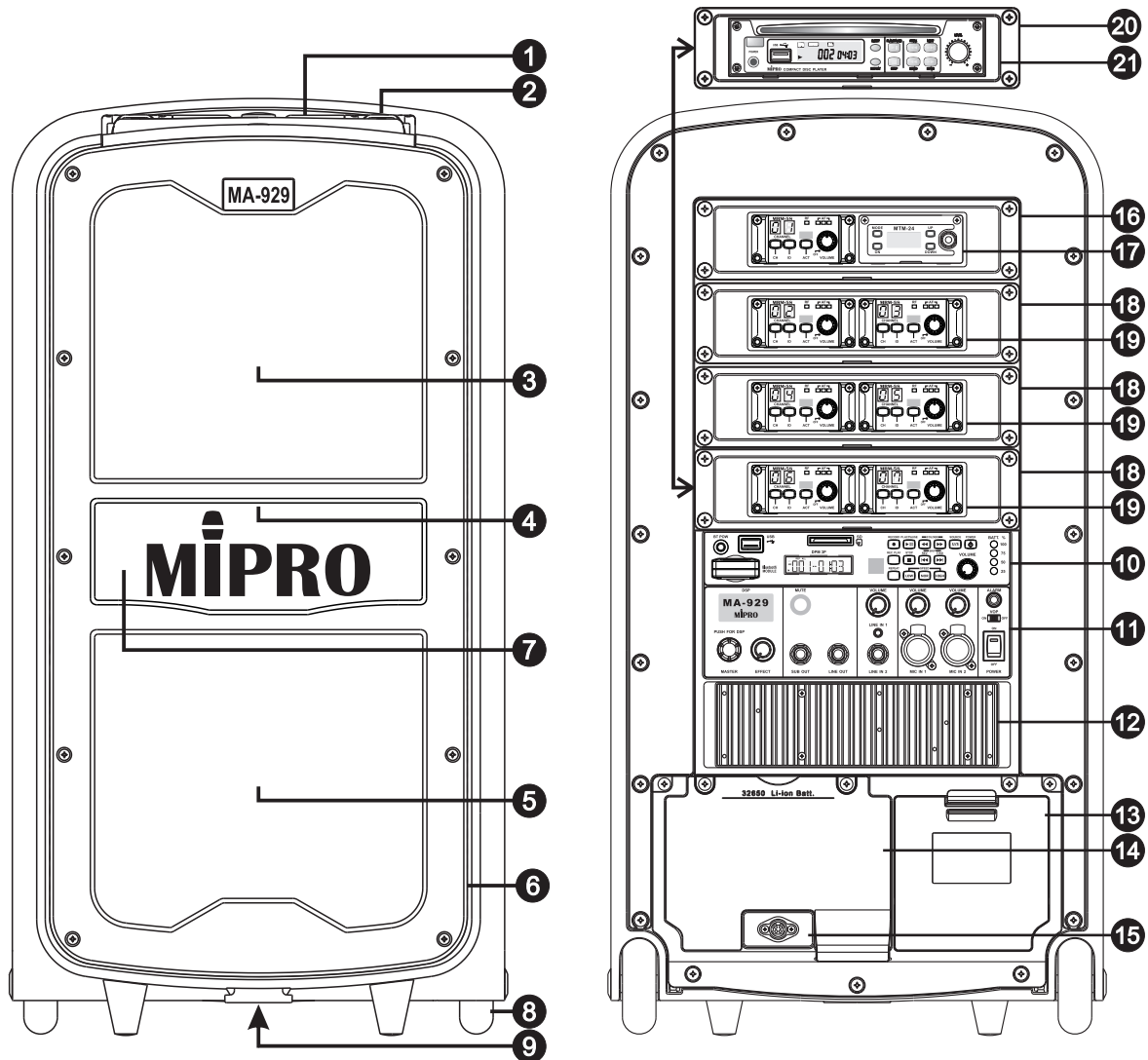
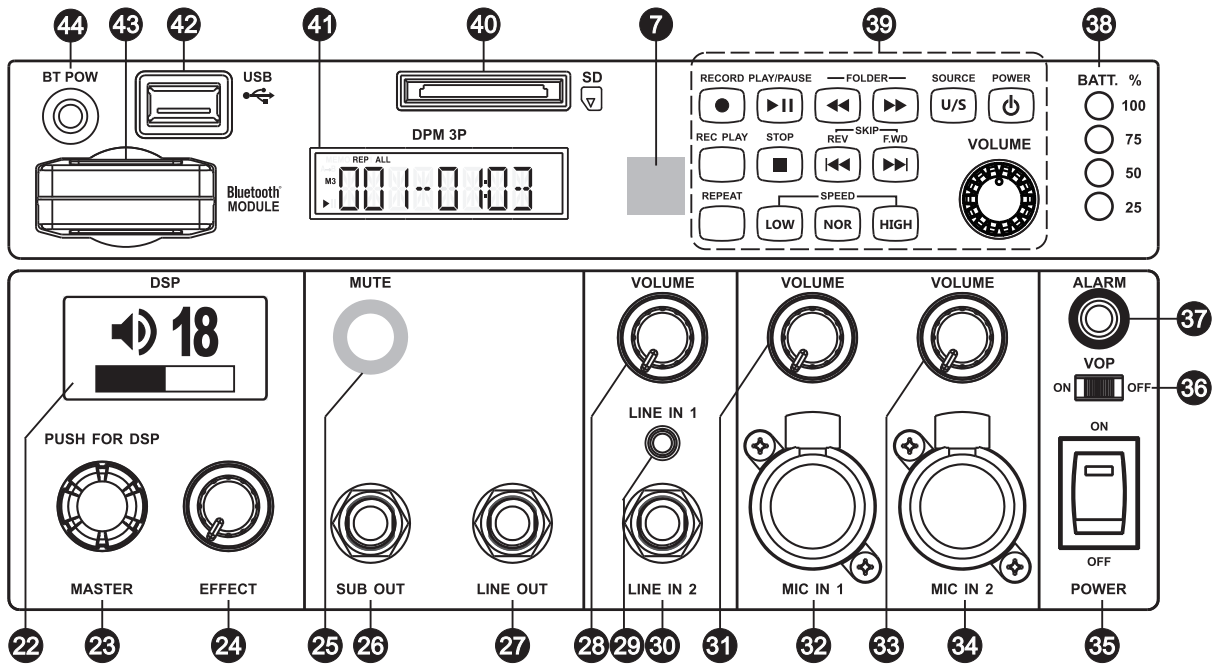

Fig. 1c: MA-929

- | | |
|---|--|
| ❶ Fixed Handle | ❷ Heat Sink |
| ❷ Retractable Carry Handle | ❸ Accessories Storage Compartment |
| ❸ Bass Speaker | ❹ Battery Compartment Cover |
| ❹ Treble Speaker | ❺ DC Power Socket |
| ❺ Bass Speaker | ❻ Optional Receiver or Interlinking Transmitter Module Frame |
| ❻ Speaker Grille | ❼ Optional Receiver or Interlinking Transmitter Module |
| ❼ IR sensor for Audio Player Remote Control | ❽ Optional Receiver Module Frame |
| ❽ Trolley Wheels | ❾ Optional Receiver Module |
| ❾ Tripod Stand Mount | ❿ Optional Audio Player Frame |
| ❿ Audio Player Control Panel | ⓫ Optional Audio Player Module |
| ⓫ Audio Control Panel | |

2. Control Panel:



- 22 DSP LCD Screen
- 23 MASTER Volume Control / DSP Control Knob
- 24 Effect Volume Control
- 25 Mute Button
- 26 6.3 Ø Subwoofer Output Jack
- 27 6.3 Ø Line Output Jack
- 28 Line Input / Bluetooth® Volume Control
- 29 3.5 Ø Line In 1 Stereo Jack
- 30 6.3 Ø Line In 2 Mono Jack
- 31 MIC IN 1 Volume Control
- 32 MIC IN 1 Balanced XLR / Unbalanced Combo Jack
- 33 MIC IN 2 Volume Control
- 34 MIC IN 2 Balanced XLR / Unbalanced Combo Jack
- 35 Master Power Switch
- 36 VOP Voice Priority Switch
- 37 Alarm Siren Button
- 38 Battery Status Indicators
- 39 Audio Player Control Panel
- 40 SD Card Slot
- 41 Audio Player LCD Screen
- 42 USB Slot
- 43 Bluetooth® Module Slot
- 44 Bluetooth® Power Button

3. Audio Player Control Panel:

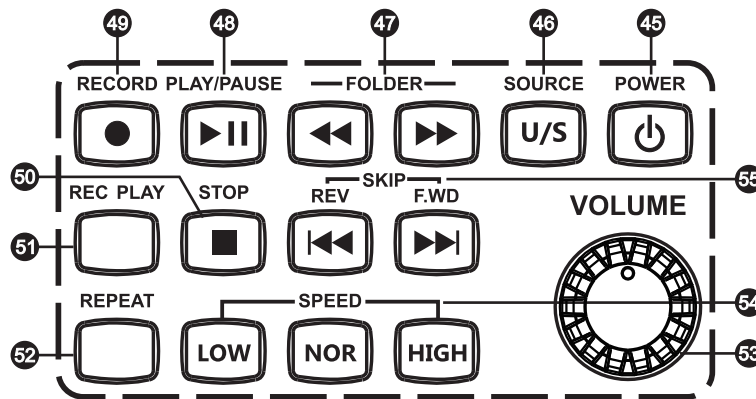

- 45 Power Button
- 46 Source Selection Button
- 47 Folder Selection Buttons
- 48 Play / Pause Button
- 49 Record Button
- 50 Stop Button
- 51 REC PLAY Button
- 52 REPEAT Button
- 53 Volume Control
- 54 Speed Adjust Button
- 55 SKIP: F.WD ►► Forward to the next track. REV ◄◄ Backward to the last track. Press and hold for fast forward / backward to the next / last track.

II. Operating Instructions

1. Power On: Pull the battery insulator down firmly and minimize all volume levels before turning on the Master Power Switch 35. The Battery Status Indicators 38 light on to indicate the power is normally supplied and flash to indicate charging. A single red color indicator lights to indicate the rechargeable battery is low on power and needs charging.

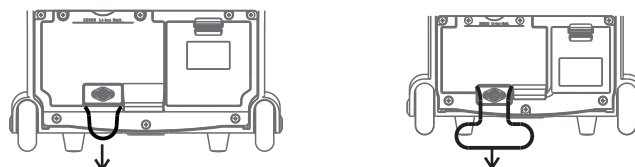

Pull the battery insulator down firmly

2. MASTER Volume Control: Rotate MASTER volume control 23 to adjust the volume of the audio output.
3. Line In and Line Out Jacks:
 - (A) Before power on, turn the LINE IN / Bluetooth® 28 down. (Caution: Once the volume is turned to the minimum, the sound of Bluetooth® pairing can't be heard.) Once power on, adjust the LINE IN volume to an adequate level.
 - (B) All audio sources are mixed to Line Out Jack 27. The volume level of each source can be individually adjusted.
4. Wired Microphone:
 - (A) Before power on, turn microphone volume levels to the minimum.
 - (B) Plug a balanced XLR microphone into MIC IN 1 32 and adjust MIC IN 1 Volume Control 31 to an adequate level.

- (C) Plug a balanced XLR microphone into MIC IN 2 ④④ and adjust MIC IN 2 Volume Control ④③ to an adequate level.
- (D) Switch VOP to ON, the volume of the playing audio mutes when the microphone is used; the playing audio unmutes when the microphone is not used. Switch VOP to OFF to disable the function.
- (E) The wired and wireless microphones can be used at the same time.

5. Mute:

- (A) Press and release the Mute Button ②⑤ , the indicator flashes. The playing audio mutes but the microphone not. Press again to disable mute.
- (B) Press and hold the Mute Button ②⑤ , the indicator turns solid. All the input signals are muted. Press again to disable mute.

6. Wireless Microphones:

- (A) Before power on, turn all volume levels to the minimum.
- (B) Power on the receiver module, and the screen lights on.
- (C) Power on the wireless transmitter, the RF indicator lights on.
- (D) Adjust the volume control clockwise to an adequate level.
- (E) Wireless receivers and other audio sources have individual volume control and can be used at the same time.
- (F) Both wired and wireless microphone has a VOP function.
- (G) Do not use two or more transmitters with one receiver at the same frequency. But, one transmitter can be used with receivers at the same frequency on multiple amplifiers to extend the sound field.
- (H) When the transmitter is not in use, ascertain to power off the receiver.

7. Pairing Bluetooth® Receiver:

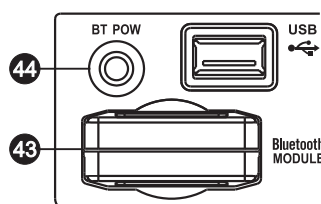

- (A) Place the Bluetooth module into the Bluetooth Slot ④③ .
- (B) Activate Bluetooth on the mobile device and bring it within the reception range.
- (C) Press and hold the Bluetooth Power Button ④④ for 3-5 seconds until the indicator alternately flashes blue and red to denote the receiver is now ready to be paired.
- (D) If the indicator doesn't light on, repeat by pressing and holding for 3-5 seconds until the indicator alternately flashes blue and red.
- (E) Enter "0000" when prompted to enter a PIN code.
- (F) Once paired and the connection is made, the indicator will alternately flash blue.
- (G) To disable the pairing, press & hold Bluetooth Power Button ④④ for 3 seconds, and the indicator dims.

- (H) For changing the connected device, power off and on the Bluetooth receiver again. Repeat the directions in “Pairing Bluetooth Receiver” to connect a different device. If the indicator alternately flashes blue and red, it denotes it's under the pairing status.
- (I) Pairing Bluetooth for two devices (Enable TWS Mode): *Bluetooth modules on both speakers must be the same version for TWS pairing. The version can be identified under search mode. Turn on one device first and operate steps A~F, then turn on the other one and do step C. Press the Bluetooth button twice for each device, during blue/red indicator light flashing intermittently, two Bluetooth receivers will pair automatically. Once paired, the blue indicator light will flash intermittently or stay on. Now play the music from the paired smartphone and get stereo sound amplification.

8. Media Player Operation:

(A) Media slots:

- (1) USB flash drive: Insert USB 2.0 into the USB slot for playing MP3 / WMA / FLAC / APE / WAV / M4A / AAC / OGG files.
- (2) SD card: Insert an SDHC card with the label facing downward into the slot. Press it again to eject the card.
- (3) Format USB and SD card before playback. The format standard is FAT 32.
- (4) Press the SOURCE button (U: USB, S: SD card) to select USB or SD card. USB plays first before the SD card.
- (5) NO DISK displays when there is no USB or SD card insert to the slot, or is unable to detect or read a media source.

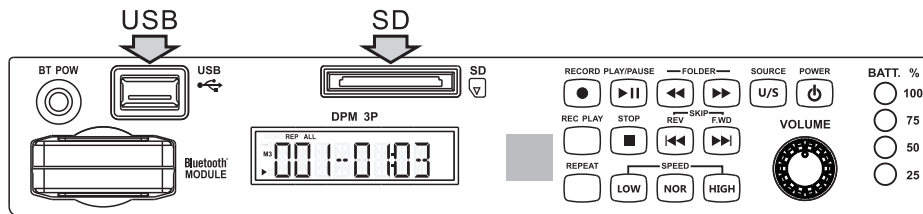

(B) Music playback:

- (1) Press PLAY/PAUSE **48** for playback. The ► icon and the track information will be displayed.
- (2) Press PLAY/PAUSE **48** again during playback to pause. II is displayed. Press PLAY/PAUSE **48** again to resume playback.
- (3) Press STOP to stop playback.
- (4) M3 is displayed when playing MP3.
- (5) Repeat tracks:
 - (a) “REP 1”: Repeat the current track.
 - (b) “F”: Repeat all tracks at the current folder.
 - (c) “ALL”: Repeat all tracks.
 - (d) “REP” disappears: Stop the repeat function.
- (6) SPEED: Allow track to play at an increased (HIGH), decreased (LOW), or Normal speed. Speed can be adjusted in 10 different steps. NOR denotes normal speed.

(C) Operating instructions for the order of playing music:

- (1) Copy all the songs one by one into a USB drive or SD card, and the playing sequence will be based upon the sequence of songs being copied.
- (2) Numbered all the songs into a folder on the PC and then copy the complete folder into a USB drive or SD card. Please note the songs must be numbered in the same sequence manner like 00, 01, 02 or 000, 001, 002 or 0000, 0001, 0002, and so on.

(D) Record tracks:

- (1) To save recording input signals into a USB drive or an SD Card, insert a USB drive or an SD card into the slot and switch SOURCE 46 to the intended media. Press the RECORD button 49 and "WAIT REC" will be shown until "STANDBY" is blinking. Then press the RECORD button 49 to start the recording process. Press the RECORD button to pause and again to resume. Press the STOP button 50 to stop recording and the file will be saved in the "REC" folder in MP3 format and the file name is RECXXXX.
- (2) Recording input can be converted into MP3 (44.1kHz, 128kbps) file format. It can be saved into a USB drive or an SD Card.
- (3) Press the REC PLAY button 51 to play the current recorded track.

(E) Play recorded tracks:

- (1) Press the REC PLAY button 51 right after recording will play the last recorded track. Press the STOP button 50 first and then press the REC PLAY button 51, it will play the first track of the REC folder.
- (2) Press the REC PLAY button 51 to enter into recorded tracks. Press the REV / F.WD button 55 to search for tracks.

9. Remote Control for Media Player:

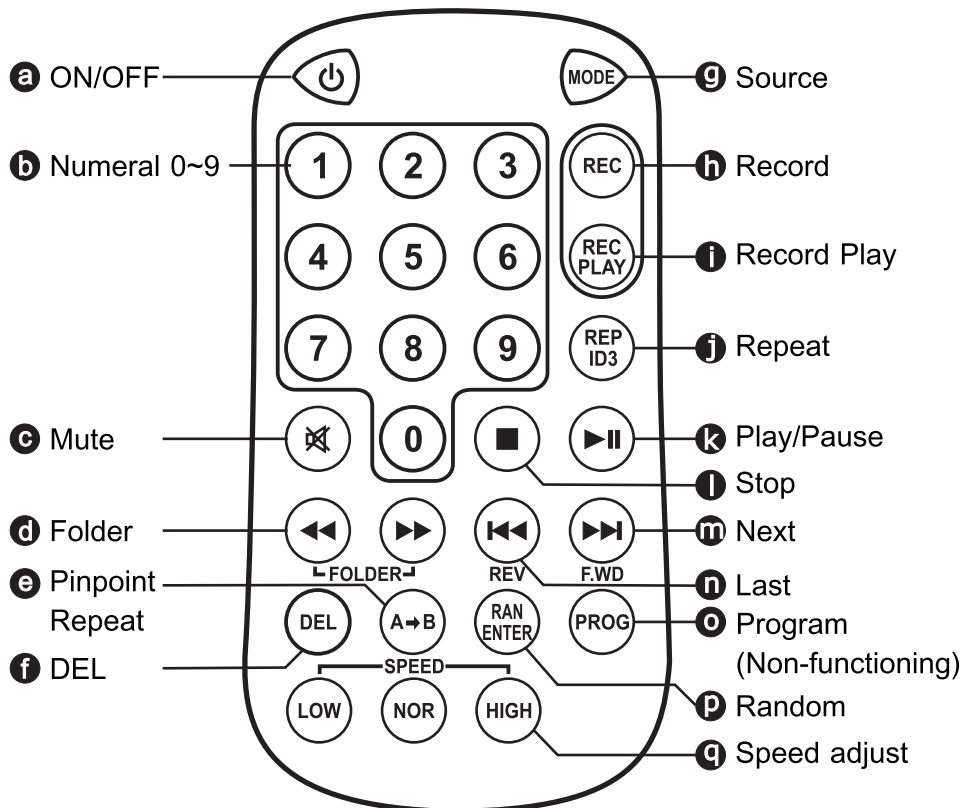

10. Remote Control Functions:

- (A) MUTE \odot : Press to mute, press again to un-mute.
- (B) Pinpoint Repeat A \rightarrow B \odot : During playback, press A \rightarrow B to pinpoint A. Press again to pinpoint B and start to pinpoint repeat playing between A and B. Press it again to cancel the function.
- (C) DEL $\text{\textcircled{f}}$: Delete button. Select the track to be deleted during playback. Press the DEL button, the LCD shows DEL FILE. Press once to delete this track. The deleted track can't be recovered.
- (D) RAN ENTER $\text{\textcircled{p}}$: Play random tracks. Press RAN ENTER to play randomly. Or use the REV or F.WD on the control panel or remote controller to play randomly.
- (E) Numeric selection for tracks:
 - (1) For a lot of tracks, use the remote control number keys to directly go to the specified track. Here are some common examples.
 - (2) $\text{\textcircled{1}} \rightarrow \text{\textcircled{3}} \rightarrow \text{\textcircled{4}}$: Press for track #134
 - (3) $\text{\textcircled{6}} \rightarrow \text{\textcircled{8}}$: Press and wait for 3 seconds for track #68
- (F) Other functions refer to 8. Media Player Control Panel.

11. Insert Battery to Remote Control:

- (A) Press down on the left small fixed latch and hold the right side of the battery seat groove gently to pull out the battery holder.
- (B) Insert the new battery with the positive upward and gently push the battery holder inward to position it.
- (C) Note: When using the remote control, the best reception distance is 3 meters from the remote control to the receiving hole on the control panel effective distance is 5 meters. The battery of the remote control is a CR2025 3V battery.

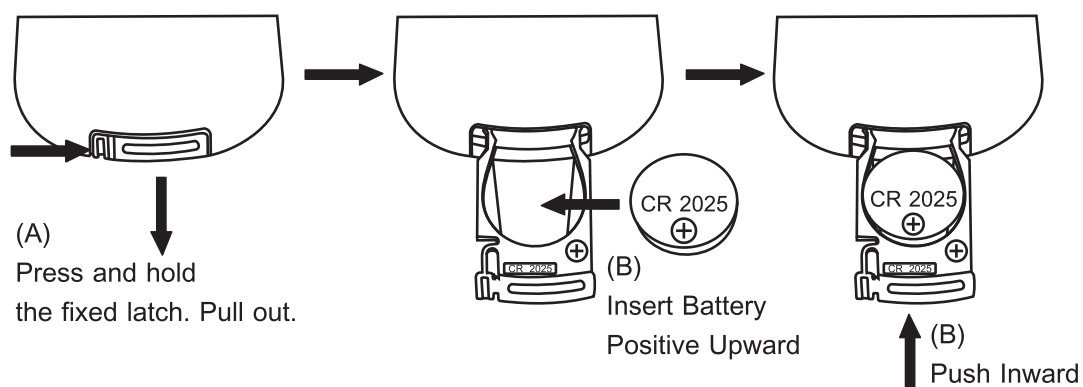

12. Notes:

- (A) Do not hit the player.
- (B) Do not place this player near strong magnetic fields and electric fields.
- (C) Do not disassemble, repair or modify this player.
- (D) Changes to the characteristics and design of the product will be made without notice.

III. DSP Functions

1. Main Menu:

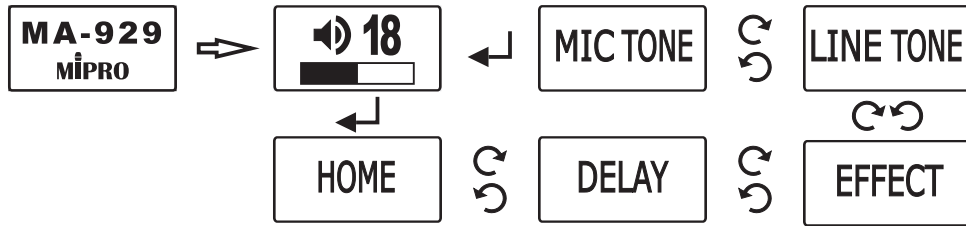

2. Explanation of Rotary Control Knob Symbols:



3. MIC TONE Setting:

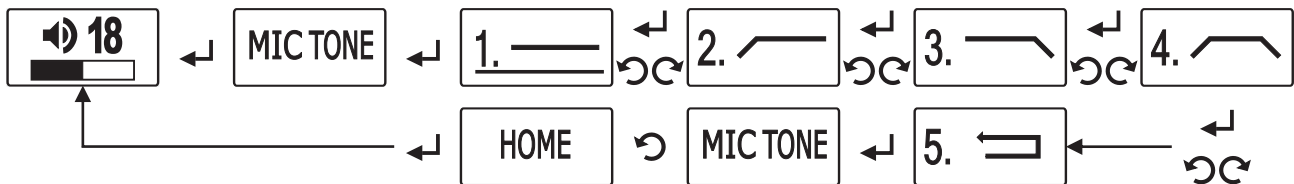

(A) Press DSP Control Rotary Knob 23 at the home screen and turn it right to select MIC TONE. Press the knob again to set frequency response curves.

(B) Turn the knob right or left to select the preset frequency response curves.

(C) One-time setting:

- (1) Select the desired curve and press the knob to activate it. Now the activated curve is underlined. Turn the knob to 5. RETURN and press to go back to MIC TONE.
- (2) Turn the knob to HOME and press to exit to the home screen.
- (3) Disregard what the final setting is, MIC TONE frequency response curves will resume to 2. LO-CUT in its next power-on.

(D) Save setting:

- (1) Select the desired curve. Press and hold the knob over 2 seconds, and the selected curve will be underlined and blink to denote it is activated and saved. Then turn the knob to 5. RETURN and press to go back to MIC TONE. (This curve and LINE TONE curve will be saved together.)
- (2) Turn the knob to HOME and press to exit to the home screen.
- (3) The saved curve will be displayed prior to others when the system is restarted.

(E) Explanation of Symbols:

1. FLAT 2. LO-CUT 3. HI-CUT 4. SPEECH
 5. RETURN

4. LINE TONE Setting:

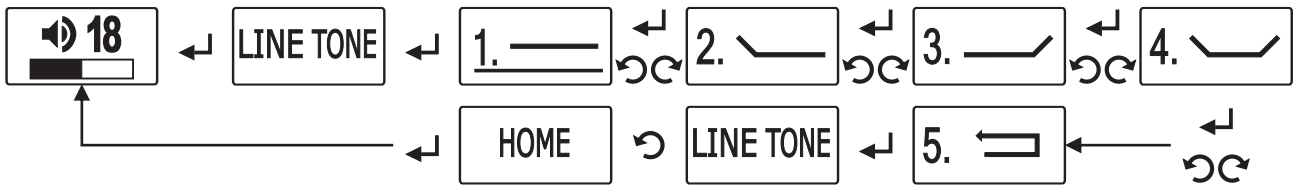

- (A) Press DSP Control Rotary Knob at the home screen and turn it right to select LINE TONE. Press the knob again to set frequency response curves.
- (B) Turn the knob right or left to select the preset frequency response curves.
- (C) One-time setting:
 - (1) Select the desired curve and press the knob to activate it. Now the activated curve is underlined. Turn the knob to 5. RETURN and press to go back to LINE TONE.
 - (2) Turn the knob to HOME and press to exit to the home screen.
 - (3) Disregard what the final setting is, LINE TONE frequency response curves will resume to 1. FLAT in its next power-on.

(D) Save settings:

- (1) Select the desired curve. Press and hold the knob over 2 seconds, and the selected curve will be underlined and blink to denote it is activated and saved. Then turn the knob to 5. RETURN and press to go back to LINE TONE. This curve and MIC TONE curve will be saved together.
- (2) Turn the knob to HOME and press to exit to the home screen.
- (3) The saved curve will be displayed prior to others when the system is restarted.

(E) Explanation of Symbols:

- 1. FLAT 2. LO-BOOST 3. HI-BOOS 4. MUSIC
- 5. RETURN

5. EFFECT Setting:

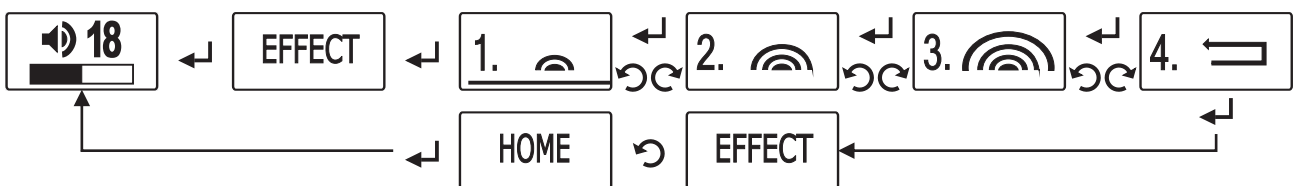

- (A) Press DSP Control Rotary Knob at the home screen and turn it right to select EFFECT. Press the knob again to set the EFFECT Mode.
- (B) Turn the knob right or left to select the preset EFFECT Modes.
- (C) Select the desired mode and press the knob to activate it, now the activated mode is underlined. Turn the knob to 4. RETURN and press to go back to EFFECT.
- (D) Turn the knob to HOME and press to save EFFECT mode and exit to the home screen.
- (E) The saved parameter will be displayed prior to others when the system is restarted.

(F) Explanation of Symbols:

- 1. SMALL HALL 2. MED HALL 3. BIG HALL 4. RETURN

6. DELAY Setting:

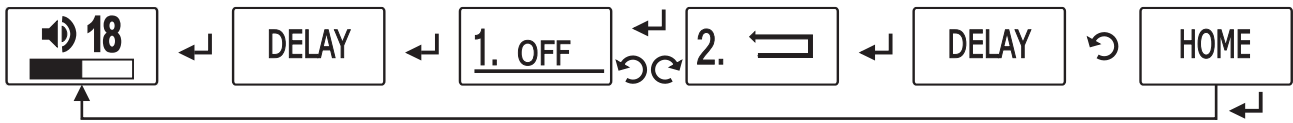

- (A) Press DSP Control Rotary Knob 23 at the home screen and turn it right to select DELAY. Press the knob again to set parameters.
- (B) Turn the knob right or left for 1. OFF or 2. [Distance Setting].
- (C) Press and hold “OFF” until the underline disappears and opens for the distance setting. Turn the knob to increase or decrease parameters every 1M within 50M.
 - (1) Select the desired parameter (e.g. 20M) and press the knob. 1. 20M is underlined to denote the delay distance. A few seconds later, it will exit to the home screen.

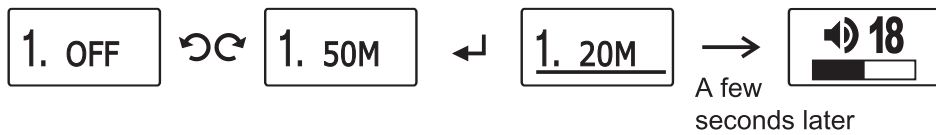

- (2) To skip the setting, don't press the knob and then the parameter will not be underlined. The setting keeps the previously saved parameter. A few seconds later, it will exit to the home screen.

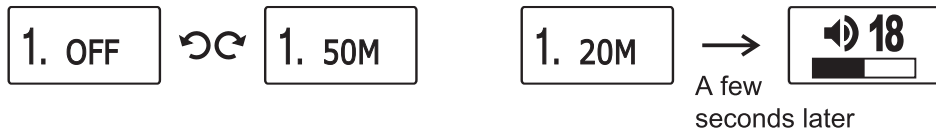

- (D) Press the knob at 2. [Distance Setting] to go back to DELAY.
- (E) Turn the knob to HOME and press to exit to the home screen.
- (F) The saved parameter will be displayed next time.

IV. Control Panel Connection

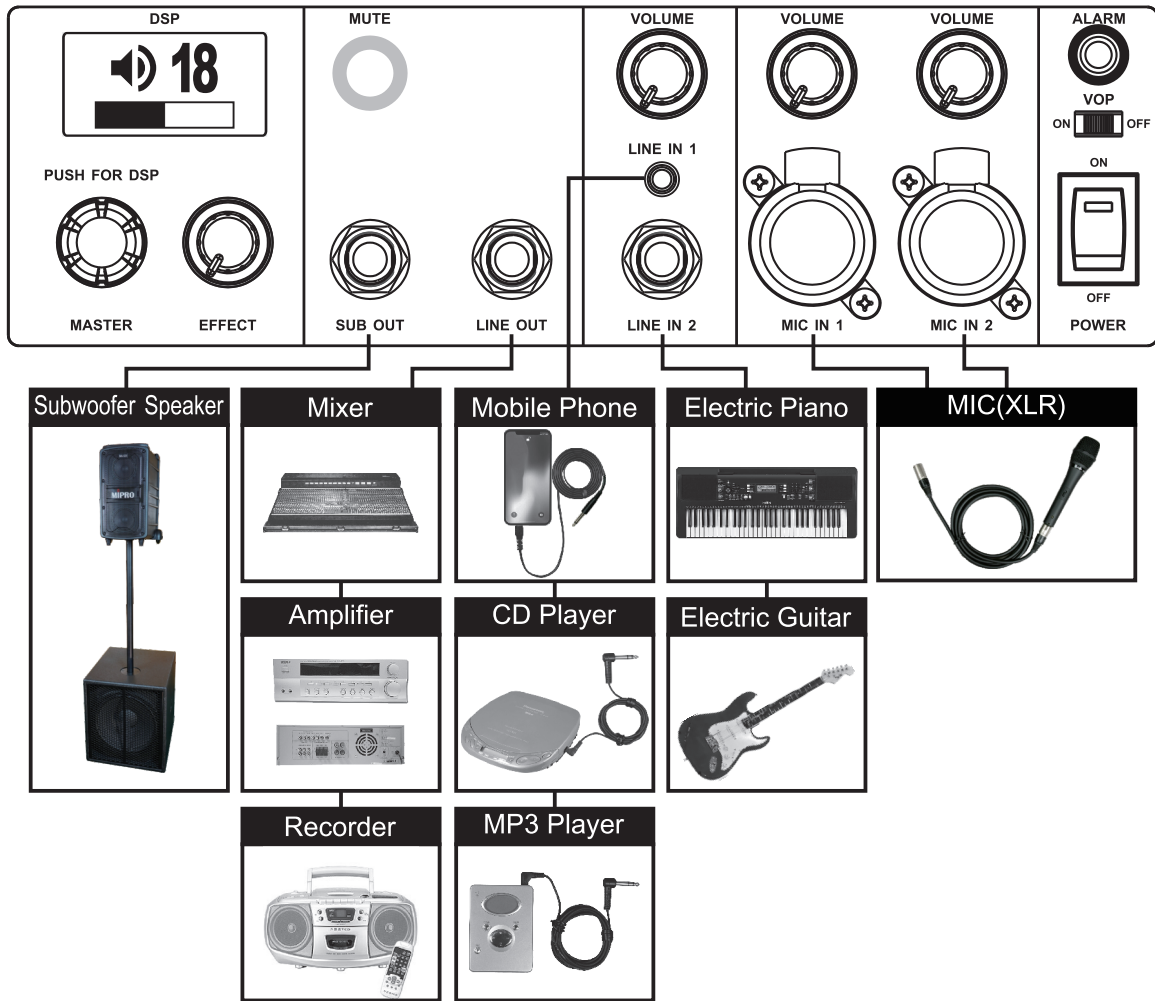

V. How to Store the Accessories

1. Push the lid hook downward of the storage and pull to remove the lid.
2. Put the accessories into the storage.
3. Insert the lid bottom into the groove of the storage and push the lid back to its original position.
4. Make sure the lid is securely fixed before rolling the device.

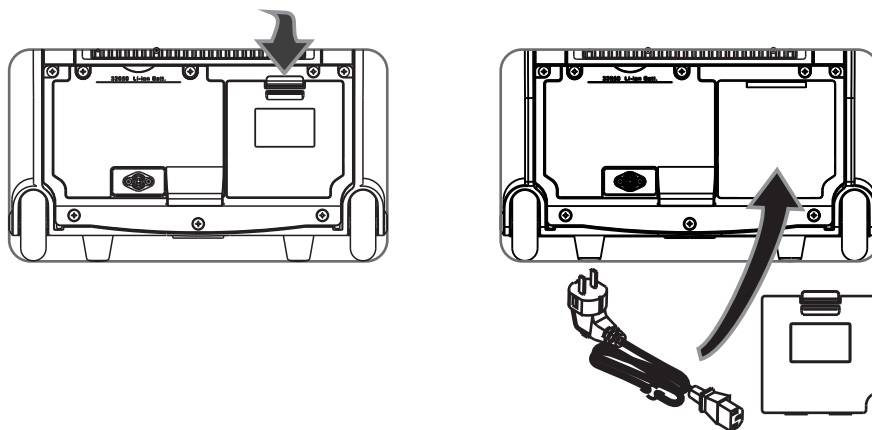

VI. How to Replace Battery

1. Remove screws from the battery compartment cover ⑭ and release the cover.
2. Insert 8 lithium-ion batteries with the positive upward. Any damage caused by incorrect polarity is excluded from the warranty.
3. Put the cover back and tighten the screws.

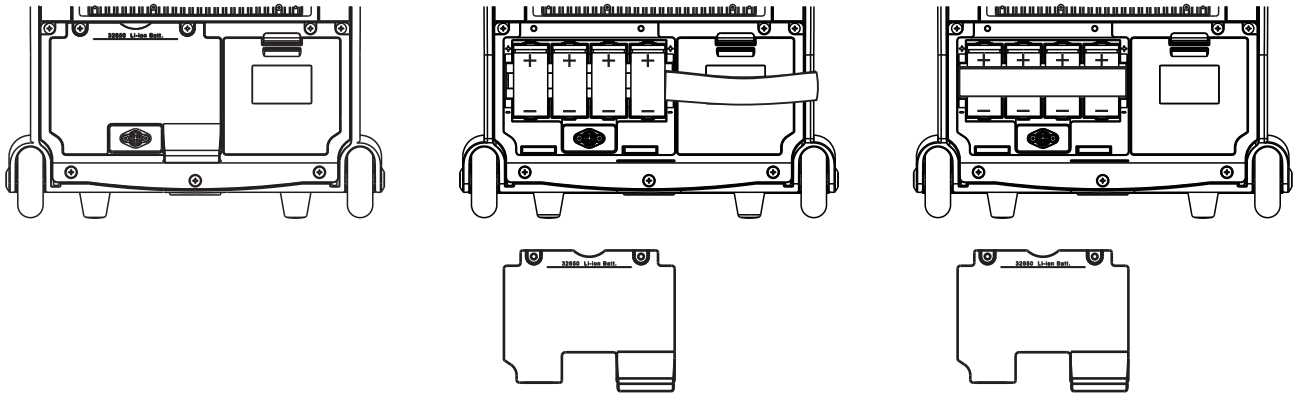

VII. Power Supply Instruction

1. How to use DC power supply:
 - (A) When 8 lithium-ion batteries are installed and fully charged, the unit can be operated continuously for approximately 6~8 hours in standby mode. However, the operating time varies depending on the playing mode (speech or music mode), loudness, and freshness of the batteries.
 - (B) In the case the power is not turned on, the Battery Meter Indicators ③⑧ will not light on. When the power is turned on, the red LED on the Master Power Switch ③⑤ will light on; meanwhile, 1 to 3 battery meter indicators light on to denote the battery power is enough for normal operation. Only 1 battery meter indicator lights on or the red LED on the power switch flashes denote the battery power is insufficient and immediate charge is necessary. If no battery meter indicator lights on when the power switch is on, it denotes the batteries are over-discharged or possibly faulty.
 - (C) Always store the sound system with the batteries fully charged and recharge every 3 months. If the batteries are not charged for an extended period, they might be over-discharged and damaged, and can't be charged anymore.
 - (D) MA-828 / MA-929 use 32650 LFP batteries; MA-727 uses 26650 LFP batteries. Replace 8 batteries all together to ensure each one has the same capacity for optimal operating hours.
2. How to use External Power Supply:
 - (A) When connecting the external power supply, the 4 battery meter indicators will light on immediately to denote that the power supply is functioning normally and the rechargeable batteries are fully charged. And, flashing battery meter indicators denote the rechargeable batteries are in charging status.
 - (B) Using the external power supply to provide power to both amplifier and rechargeable batteries. You can disconnect the external power supply anytime during operation, the device will automatically maintain continuous operation with inserted rechargeable batteries.

VIII. How to Install Wireless Receiver Modules

1. Each unit has two built-in wireless receiver modules. MA-828 / MA-929 can install more optional wireless receiver modules.
2. Installation or detachment of wireless receiver modules:
 - (A) Remove the screws on the module frame panel.
 - (B) Remove the panel with a flat-head screwdriver.
 - (C) Insert the receiver module into the slot.
 - (D) Push firmly to make sure the module is tightly fitted into the slot.
 - (E) Tighten the screws.

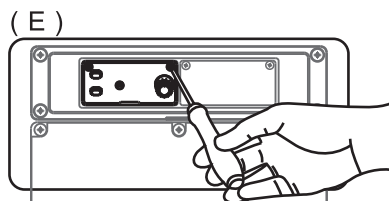
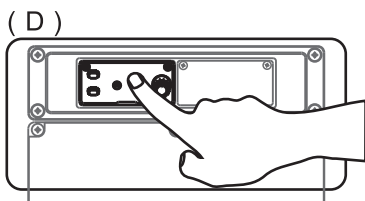
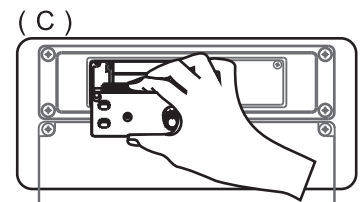
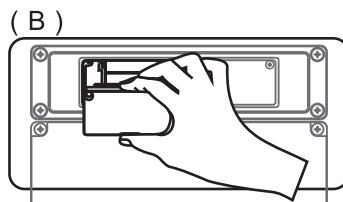
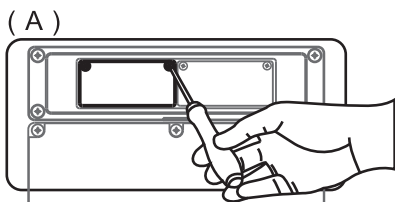

3. For operating instructions of the wireless receiver modules, please refer to the user guide supplied.

IX. How to Install Wireless Interlinking Transmitter Module

1. Install a wireless interlinking transmitter module on the top / right side slot only. Fig 1a, 1b, 1c.
2. Set MIC TONE under DSP function at 1. — FLAT when operating wireless interlinking transmitter module.
3. Installation or detachment.
 - (A) Remove the screws on the module frame panel.
 - (B) Remove the panel with a flat-head screwdriver.
 - (C) Insert the wireless interlinking transmitter module into the slot.
 - (D) Push firmly to make sure the module is tightly fitted into the slot.
 - (E) Tighten the screws.

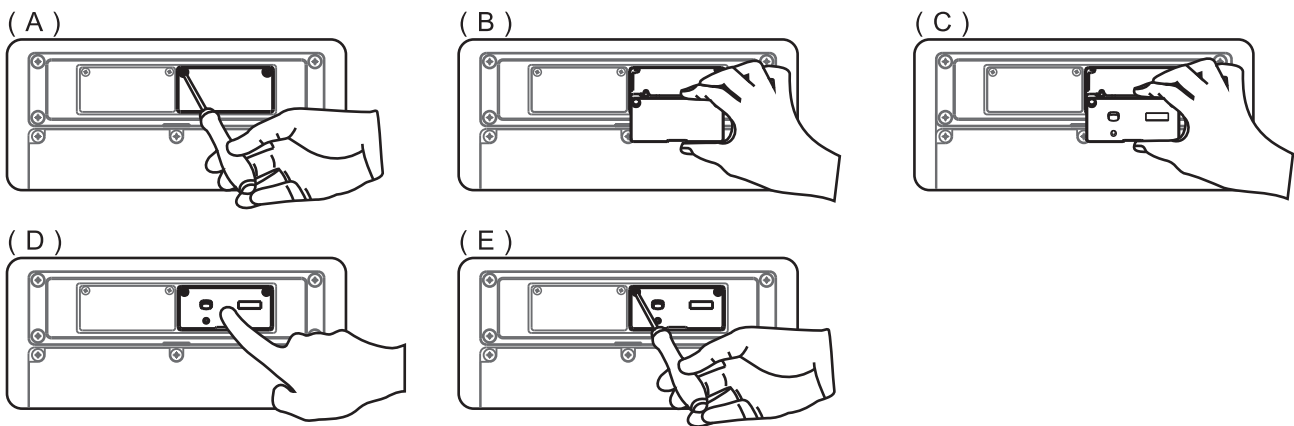

4. Operating instructions of the wireless interlinking transmitter module refer to the user guide supplied.

X. Other Operating Instructions

1. How to pull up the carry handle.

- (A) Pull up the horizontally folded retractable carry handle.
- (B) Firmly push the carry handle downward to fix the handle.
- (C) Press the button on the carry handle to pull out the 3-step retractable carry handle.

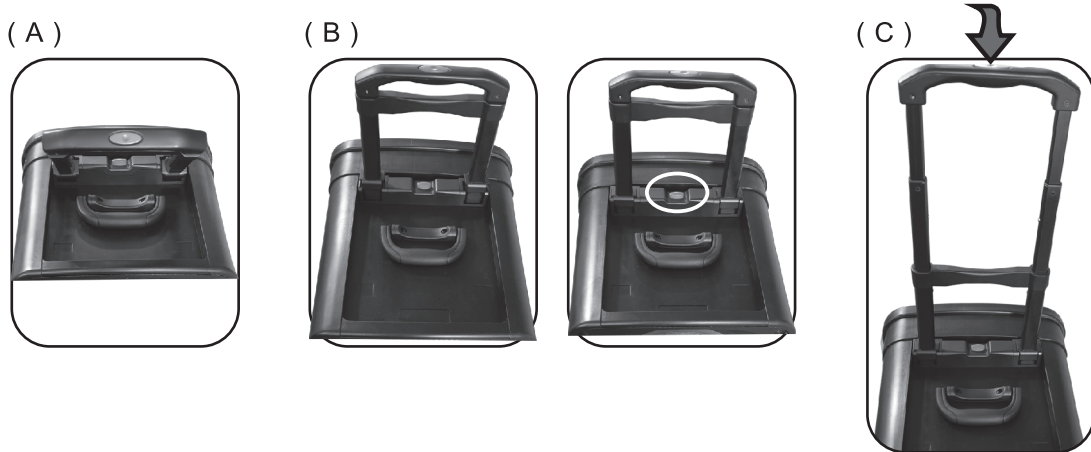

2. How to store a retractable carry handle.

- (A) Press the button on the handle to retract it.
- (B) Press the red button under the carry handle by one hand; pull up the carry handle by the other hand. Now the carry handle is loosened and can be folded horizontally.
- (C) Put the carry handle inside the storage slot.

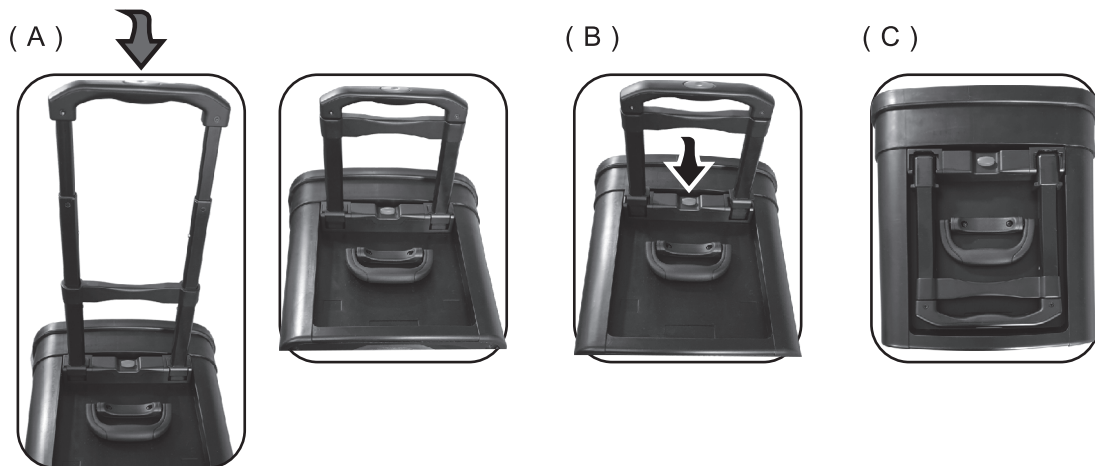

3. This system can be hand-carried, trolleyed and installed on a tripod stand.



Installed on a tripod stand

4. Every system can be connected with a subwoofer cabinet.



Mount the system on a speaker stand with a subwoofer, then connect the Sub Out  jack of the system to the input of the subwoofer, and the portable PA system becomes a full-range Line Array speaker system.

XI. Notes

1. Minimized all the volume controls before power turned on.
2. Each audio source has individual volume control, and all signals are mixed and sent to the amplifier.
3. Each audio input can be played and recorded at the same time.
4. This sound system equips the professional wireless microphone system and presents premium and professional sound quality.
5. This sound system delivers clear and powerful sound with high-efficiency speakers and directional wireless microphones. We recommend using a microphone next to or behind the sound system. NEVER closely place any wired or wireless microphone in front of the speaker, otherwise, feedback will occur.
6. MA-727/MA-828/MA-929 is not allowed to install other optional audio players by users. Should playing CD or other audio sources be required, please order MA-828/MA-929 installed with another optional audio player from the manufacturer. Otherwise, users can connect other audio players to LINE IN.
7. Operating instructions of wireless microphones refer to the user guides of the wireless microphone system.
8. Refer to the actual product in the event of product description discrepancy.
9. Frequency range, output power and maximum deviation are country-dependent.

MIPRO[®]
MICROPHONE PROFESSIONALS

MIPRO Electronics Co., Ltd
Headquarters: No. 814, Beigang Rd., Chiayi City 600079, Taiwan
Tel : +886.5.238.0809 Fax : +886.5.238.0803
www.mipro.com.tw mipro@mipro.com.tw

All rights reserved. YM 022/02

Do not copy or forward without prior approvals of MIPRO.
Specifications and design subject to change without notice.



2005-08-18



2 CE67 1 B